

● 転がり軸受

● 深溝玉軸受

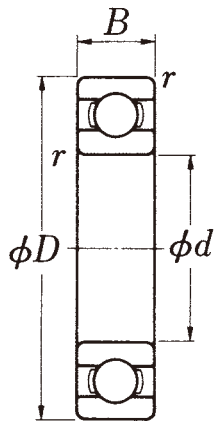

● 6000

品番	価格				寸法		
	オープン	Z・ZZ	RS・RU 2RS・2RU	ZZNR	d (φ)	D (φ)	B (mm)
6000	540	620	700	730	10	26	8
01	550	630	720	740	12	28	8
02	610	700	790	820	15	32	9
03	630	730	820	850	17	35	10
6004	680	780	880	920	20	42	12
05	780	900	1,010	1,050	25	47	12
06	930	1,070	1,210	1,260	30	55	13
07	1,150	1,320	1,500	1,550	35	62	14
6008	1,490	1,710	1,940	2,010	40	68	15
09	1,930	2,220	2,510	2,610	45	75	16
10	2,300	2,650	2,990	3,110	50	80	16
11	2,910	3,350	3,780	3,930	55	90	18
6012	3,270	3,760	4,250	4,420	60	95	18
13	3,950	4,540	5,140	5,330	65	100	18
14	4,530	5,210	5,890	6,120	70	110	20
15	5,280	6,070	6,860	7,130	75	115	20
6016	6,260	7,200	8,140	8,450	80	125	22
17	7,420	8,530	9,650	10,000	85	130	22
18	8,660	9,960	11,300	11,700	90	140	24
19	10,300	11,800	13,400	13,900	95	145	24
6020	11,700	13,500	15,200	15,800	100	150	24
21	16,800	19,300	21,800	-	105	160	26
22	21,600	24,800	28,100	-	110	170	28
24	23,700	27,300	30,800	-	120	180	28
6026	28,100	32,300	36,500	-	130	200	33
28	31,900	36,700	41,500	-	140	210	33
30	44,600	51,300	58,000	-	150	225	35

● 16000

品番	価格	寸法		
	オープン	d (φ)	D (φ)	B (mm)
16002	770	10	26	8
03	800	12	28	8
04	870	15	32	9
05	960	17	35	10
16006	1,150	20	42	12
07	1,450	25	47	12
08	1,730	30	55	13
09	2,360	35	62	14
16010	2,640	40	68	15
11	3,330	45	75	16
12	3,770	50	80	16
13	4,530	55	90	18
16014	5,790	60	95	18
15	6,290	65	100	18
16	7,270	70	110	20
17	8,700	75	115	20
16018	10,100	80	125	22
19	11,600	85	130	22
20	12,900	90	140	24
21	16,500	95	145	24
16022	19,500	100	150	24
24	22,600	105	160	26
26	28,200	110	170	28
28	32,100	120	180	28
30	40,500	130	200	33

● 6200

品番	価格				寸法		
	オープン	Z・ZZ	RS・RU 2RS・2RU	ZZNR	d (φ)	D (φ)	B (mm)
6200	450	520	590	610	10	30	9
01	490	560	640	660	12	32	10
02	540	620	700	730	15	35	11
03	630	730	820	850	17	40	12
6204	710	820	920	960	20	47	14
05	840	970	1,090	1,130	25	52	15
06	1,100	1,270	1,430	1,490	30	62	16
07	1,460	1,680	1,900	1,970	35	72	17
6208	1,880	2,160	2,440	2,540	40	80	18
09	2,300	2,650	2,990	3,110	45	85	19
10	2,680	3,080	3,480	3,620	50	90	20
11	3,130	3,600	4,070	4,230	55	100	21
6212	3,640	4,190	4,730	4,910	60	110	22
13	4,600	5,290	5,980	6,210	65	120	23
14	5,160	5,930	6,710	6,970	70	125	24
15	5,690	6,540	7,400	7,680	75	130	25
6216	6,790	7,810	8,830	9,170	80	140	26
17	8,570	9,860	11,100	11,600	85	150	28
18	10,300	11,800	13,400	13,900	90	160	30
19	12,000	13,800	15,600	16,200	95	170	32
6220	14,100	16,200	18,300	-	100	180	34
21	20,400	23,500	26,500	-	105	190	36
22	26,200	30,100	34,100	-	110	200	38
24	37,200	42,800	48,400	-	120	215	40
6226	44,400	51,100	57,700	-	130	230	40
28	56,200	64,600	73,100	-	140	250	42
30	83,400	95,900	-	-	150	270	45

●円すいころ軸受



●30200

品番	価格	寸法			
	プレス	d	D	B	T
30202	1,230	15	35	11	11.75
03	1,330	17	40	12	13.25
04	1,370	20	47	14	15.25
05	1,540	25	52	15	16.25
30206	1,840	30	62	16	17.25
07	2,120	35	72	17	18.25
08	2,520	40	80	18	19.75
09	3,170	45	85	19	20.75
30210	3,450	50	90	20	21.75
11	3,920	55	100	21	22.75
12	4,550	60	110	22	23.75
13	5,550	65	120	23	24.75
30214	6,740	70	125	24	26.25
15	7,080	75	130	25	27.25
16	8,100	80	140	26	28.25
17	10,800	85	150	28	30.5
30218	12,900	90	160	30	32.5
19	16,400	95	170	32	34.5
20	19,300	100	180	34	37
21	30,300	105	190	36	39
30222	34,700	110	200	38	41
24	52,800	120	215	40	43.5

●30300

品番	価格	寸法			
	プレス	d	D	B	T
30302	1,360	15	42	13	14.25
03	1,390	17	47	14	15.25
04	1,470	20	52	15	16.25
05	1,830	25	62	17	18.25
30306	2,180	30	72	19	20.75
07	2,570	35	80	21	22.75
08	3,620	40	90	23	25.25
09	4,150	45	100	25	27.25
30310	4,940	50	110	27	29.25
11	6,270	55	120	29	31.5
12	7,480	60	130	31	33.5
13	9,570	65	140	33	36
30314	11,700	70	150	35	38
15	14,600	75	160	37	40
16	19,100	80	170	39	42.5
17	22,700	85	180	41	44.5
30318	28,700	90	190	43	46.5
19	36,100	95	200	45	49.5
20	46,700	100	215	47	51.5
21	66,300	105	225	49	53.5
30322	75,000	110	240	50	54.5
24	90,400	120	260	55	59.5

●32200

品番	価格	寸法			
	プレス	d	D	B	T
32204	1,860	20	47	18	19.25
05	1,930	25	52	18	19.25
06	2,100	30	62	20	21.25
07	2,450	35	72	23	24.25
32208	2,800	40	80	23	24.75
09	3,540	45	85	23	24.75
10	3,780	50	90	23	24.75
11	4,330	55	100	25	26.75
32212	5,160	60	110	28	29.75
13	6,890	65	120	31	32.75
14	7,580	70	125	31	33.25
15	8,290	75	130	31	33.25
32216	9,300	80	140	33	35.25
17	11,500	85	150	36	38.5
18	15,100	90	160	40	42.5
19	19,000	95	170	43	45.5
32220	22,600	100	180	46	49
21	33,900	105	190	50	53
22	39,900	110	200	53	56
24	63,100	120	215	58	61.5

●32300

品番	価格	寸法			
	プレス	d	D	B	T
32305	2,250	25	62	24	25.25
06	2,670	30	72	27	28.75
07	3,360	35	80	31	32.75
08	4,640	40	90	33	35.25
32309	5,750	45	100	36	38.25
10	6,950	50	110	40	42.25
11	8,360	55	120	43	45.5
12	10,500	60	130	46	48.5
32313	14,400	65	140	48	51
14	19,200	70	150	51	54
15	24,000	75	160	55	58
16	26,700	80	170	58	61.5
32317	38,000	85	180	60	63.5
18	54,800	90	190	64	67.5
19	66,300	95	200	67	71.5
20	84,700	100	215	73	77.5
32321	97,400	105	225	77	81.5
22	112,000	110	240	80	84.5
24	139,000	120	260	86	90.5

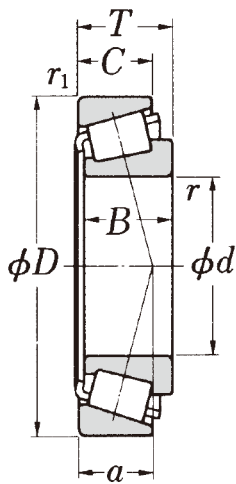

●32000

品番	価格	寸法			
	プレス	d	D	B	T
32004	1,830	20	42	15	15
05	1,900	25	47	15	15
06	2,060	30	55	16	17
07	2,260	35	62	17	18
32008	2,980	40	68	18	19
09	3,560	45	75	19	20
10	3,990	50	80	19	20
11	4,520	55	90	22	23
32012	5,460	60	95	22	23
13	6,220	65	100	22	23
14	7,440	70	110	24	25
15	8,840	75	115	24	25
32016	10,500	80	125	27	29
17	12,300	85	130	27	29
18	14,800	90	140	30	32
19	18,600	95	145	30	32
32020	22,700	100	150	30	32
21	27,700	105	160	33	35
22	32,900	110	170	36	38
24	48,400	120	180	36	38
32026	54,800	130	200	42	45
28	67,400	140	210	42	45
30	93,000	150	225	48	48

●30300D

品番	価格	寸法			
	プレス	d	D	B	T
30305D	2,380	25	62	17	18.25
06D	2,800	30	72	19	20.75
07D	3,480	35	80	21	22.75
08D	4,520	40	90	23	25.25
30309D	5,750	45	100	25	27.25
10D	6,950	50	110	27	29.25
11D	8,170	55	120	29	31.5
12D	9,930	60	130	31	33.5
30313D	13,000	65	140	33	36
14D	16,400	70	150	35	38
15D	21,100	75	160	37	40
16D	24,700	80	170	39	42.5
30317D	30,300	85	180	41	44.5
18D	38,800	90	190	43	46.5
19D	48,200	95	200	45	49.5
20D	73,600	100	215	47	51.5
30321D	109,000	105	225	49	53.5
22D	121,000	110	240	50	54.5
24D	153,000	120	260	55	59.5

●アンギュラ玉軸受

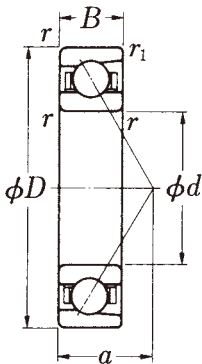

7000
7200
7300

●7000

品番	価格		寸法		
	もみ抜き		d (φ)	D (φ)	B(mm)
7000	2,040		10	26	8
01	2,070		12	28	8
02	2,400		15	32	9
03	2,460		17	35	10
7004	2,790		20	42	12
05	3,140		25	47	12
06	3,460		30	55	13
07	3,690		35	62	14
7008	4,590		40	68	15
09	5,580		45	75	16
10	6,420		50	80	16
11	7,530		55	90	18
7012	8,770		60	95	18
13	11,000		65	100	18
14	12,400		70	110	20
15	13,800		75	115	20
7016	16,400		80	125	22
17	19,300		85	130	22
18	22,000		90	140	24
19	25,100		95	145	24
7020	29,300		100	150	24
21	35,600		105	160	26
22	43,500		110	170	28
24	49,300		120	180	28
7026	60,800		130	200	33
28	72,500		140	210	33
30	98,300		150	225	35

●7200

品番	価格		寸法		
	プレス	もみ抜き	d (φ)	D (φ)	B (mm)
7201	1,720	2,580	12	32	10
02	1,980	2,970	15	35	11
03	2,030	3,050	17	40	12
04	2,320	3,480	20	47	14
7205	2,580	3,870	25	52	15
06	2,850	4,280	30	62	16
07	3,250	4,880	35	72	17
08	4,220	6,330	40	80	18
7209	4,600	6,900	45	85	19
10	5,310	7,970	50	90	20
11	6,230	9,350	55	100	21
12	7,200	10,800	60	110	22
7213	9,100	13,700	65	120	23
14	10,200	15,300	70	125	24
15	11,200	16,800	75	130	25
16	13,500	20,300	80	140	26
7217	16,000	24,000	85	150	28
18	17,900	26,900	90	160	30
19	20,600	30,900	95	170	32
20	23,400	35,100	100	180	34
7221	-	43,800	105	190	36
22	-	57,000	110	200	38
24	-	70,800	120	215	40
26	-	96,400	130	230	40
7228	-	111,000	140	250	42
30	-	169,000	150	270	45

●7300

品番	価格		寸法		
	プレス	もみ抜き	d (φ)	D (φ)	B (mm)
7302	1,800	2,700	15	42	13
03	2,020	3,030	17	47	14
04	2,320	3,480	20	52	15
05	2,970	4,460	25	62	17
7306	3,820	5,730	30	72	19
07	4,810	7,220	35	80	21
08	5,430	8,150	40	90	23
09	6,050	9,080	45	100	25
7310	7,210	10,800	50	110	27
11	8,490	12,700	55	120	29
12	10,500	15,800	60	130	31
13	12,700	19,100	65	140	33
7314	15,600	23,400	70	150	35
15	19,600	29,400	75	160	37
16	23,700	35,600	80	170	39
17	26,400	39,600	85	180	41
7318	35,100	52,700	90	190	43
19	44,200	66,300	95	200	45
20	57,000	85,500	100	215	47
21	-	99,000	105	225	49
7322	-	115,000	110	240	50
24	-	174,000	120	260	55
26	-	216,000	130	280	58
28	-	261,000	140	300	62
7330	-	352,000	150	320	65

●深みぞ玉軸受

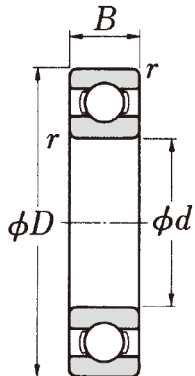

6400

●6400

品番	価格		寸法		
	もみ抜き		d (φ)	D (φ)	B(mm)
6403	3,080		17	62	17
04	4,000		20	72	19
05	4,810		25	80	21
06	6,050		30	90	23
6407	7,300		35	100	25
08	9,150		40	110	27
09	10,800		45	120	29
10	12,800		50	130	31
6411	15,300		55	140	33
12	18,400		60	150	35
13	23,700		65	160	37
14	34,000		70	180	42
6415	41,500		75	190	45
16	52,800		80	200	48
17	74,000		85	210	52
18	83,800		90	225	54

●複列自動調心玉軸受

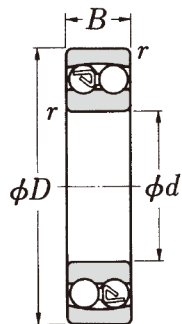

円筒穴

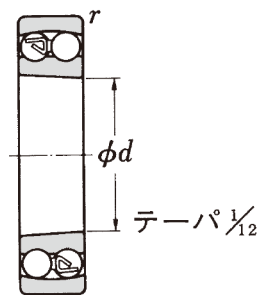

テーパー穴(K)

●1200・1200K

品番	価格	寸法		
		プレス	d (φ)	D (φ)
1200	1,600	10	30	9
01	1,650	12	32	10
02	1,710	15	35	11
03	1,950	17	40	12
1204 (K)	2,280	20	47	14
05 (K)	2,530	25	52	15
06 (K)	3,130	30	62	16
07 (K)	3,630	35	72	17
1208 (K)	4,130	40	80	18
09 (K)	4,530	45	85	19
10 (K)	5,080	50	90	20
11 (K)	5,840	55	100	21
1212 (K)	6,620	60	110	22
13 (K)	8,250	65	120	23
14	9,290	70	125	24
15 (K)	10,900	75	130	25
1216 (K)	12,300	80	140	26
17 (K)	15,500	85	150	28
18 (K)	18,500	90	160	30

●1300・1300K

品番	価格	寸法		
		プレス	d (φ)	D (φ)
1302	2,390	15	42	13
03	2,680	17	47	14
04 (K)	3,110	20	52	15
05 (K)	3,770	25	62	17
1306 (K)	4,530	30	72	19
07 (K)	5,010	35	80	21
08 (K)	5,680	40	90	23
09 (K)	6,830	45	100	25
1310 (K)	8,000	50	110	27
11 (K)	9,300	55	120	29
12 (K)	11,600	60	130	31
13 (K)	15,500	65	140	33
1314	18,500	70	150	35
15 (K)	21,000	75	160	37
16 (K)	25,000	80	170	39
17 (K)	29,600	85	180	41
1318 (K)	37,100	90	190	43

●2200・2200K

品番	価格	寸法		
		プレス	d (φ)	D (φ)
2200	1,900	10	30	14
01	1,960	12	32	14
02	2,050	15	35	14
03	2,300	17	40	16
2204 (K)	2,620	20	47	18
05 (K)	2,940	25	52	18
06 (K)	3,620	30	62	20
07 (K)	4,240	35	72	23
2208 (K)	4,730	40	80	23
09 (K)	5,280	45	85	23
10 (K)	5,680	50	90	23
11 (K)	6,850	55	100	25
2212 (K)	8,510	60	110	28
13 (K)	10,900	65	120	31

●2300・2300K

品番	価格	寸法		
		プレス	d (φ)	D (φ)
2302	2,610	15	42	17
03	2,940	17	47	19
04 (K)	3,340	20	52	21
05 (K)	4,300	25	62	24
2306 (K)	5,290	30	72	27
07 (K)	6,290	35	80	31
08 (K)	7,290	40	90	33
09 (K)	8,920	45	100	36
2310 (K)	10,900	50	110	40
11 (K)	13,400	55	120	43
12 (K)	16,500	60	130	46

●複列深溝玉軸受

●4200

品番	価格	寸法		
		プレス	d (φ)	D (φ)
4203	5,140	17	40	16
04	5,370	20	47	18
05	5,750	25	52	18
06	6,610	30	62	20
4207	8,230	35	72	23
08	9,470	40	80	23
09	11,100	45	85	23
10	13,000	50	90	23
4211	16,900	55	100	25
12	20,200	60	110	28
13	26,600	65	120	31

●4300

品番	価格	寸法		
		プレス	d (φ)	D (φ)
4304	7,200	20	52	21
05	8,230	25	62	24
06	9,870	30	72	27
07	11,300	35	80	31
4308	14,500	40	90	33
09	27,300	45	100	36
10	28,200	50	110	40
11	31,500	55	120	43

●5200

品番	価格	寸法		
		プレス	d (φ)	D (φ)
5203	3,710	17	40	17.5
04	4,090	20	47	20.6
05	5,000	25	52	20.6
06	5,930	30	62	23.8
5207	7,430	35	72	27
08	9,290	40	80	30.2
09	10,600	45	85	30.2
10	11,800	50	90	30.2
5211	13,600	55	100	33.3
12	16,000	60	110	36.5
13	19,200	65	120	38.1
14	21,000	70	125	39.7

●5300

品番	価格	寸法		
		プレス	d (φ)	D (φ)
5304	5,450	20	52	22.2
05	6,530	25	62	25.4
06	7,790	30	72	30.2
07	9,290	35	80	34.9
5308	11,500	40	90	36.5
09	13,500	45	100	39.7
10	18,800	50	110	44.4
11	20,700	55	120	49.2

●複列アンギュラ玉軸受

●円筒ころ軸受

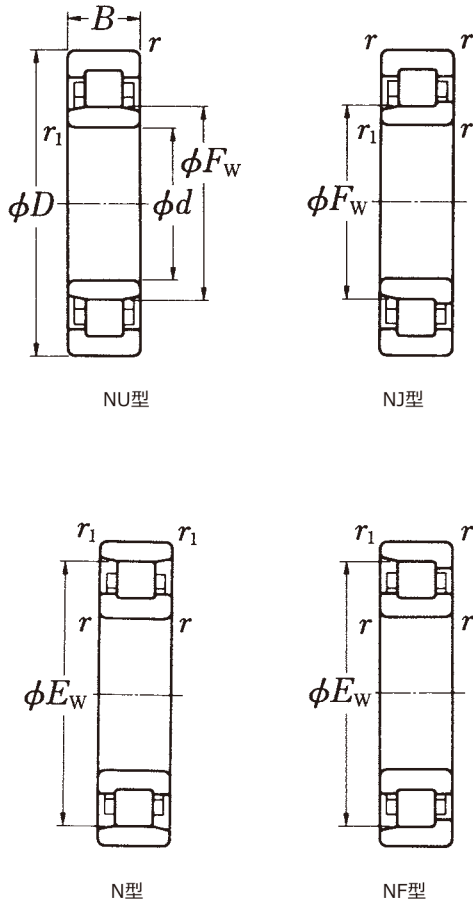

●N・NF・NU・NJ

品番	価格				寸法		
	N	NF	NU	NJ	d (φ)	D (φ)	B(mm)
203	3,230	3,550	3,320	3,500	17	40	12
04	3,760	3,770	3,650	3,840	20	47	14
05	4,030	4,000	3,830	4,120	25	52	15
06	4,820	4,210	4,410	4,940	30	62	16
07	5,770	4,870	4,800	5,870	35	72	17
208	6,590	5,810	5,420	6,740	40	80	18
09	7,280	6,980	6,240	7,440	45	85	19
10	8,220	8,010	6,640	8,340	50	90	20
11	9,510	9,620	7,800	9,730	55	100	21
12	11,000	11,200	9,060	11,100	60	110	22
213	12,900	13,700	11,000	13,300	65	120	23
14	14,200	15,100	11,500	14,400	70	125	24
15	17,800	19,400	12,500	19,000	75	130	25
16	19,600	19,600	14,900	19,200	80	140	26
17	20,700	22,100	17,000	21,500	85	150	28
218	25,800	27,200	20,800	26,600	90	160	30
19	29,500	30,000	23,900	30,500	95	170	32
20	37,000	37,300	32,200	38,800	100	180	34
21	57,100	59,000	53,100	60,500	105	190	36
22	63,300	67,000	57,400	62,200	110	200	38
24	72,000	86,500	69,800	71,000	120	215	40

品番	価格				寸法		
	N	NF	NU	NJ	d (φ)	D (φ)	B(mm)
304	4,030	3,300	3,810	3,980	20	52	15
05	4,750	4,190	4,590	4,640	25	62	17
06	5,750	5,020	5,350	5,550	30	72	19
07	6,610	5,050	6,470	6,710	35	80	21
08	8,020	7,940	7,730	8,130	40	90	23
309	9,890	9,450	9,060	9,970	45	100	25
10	11,300	10,900	10,700	11,400	50	110	27
11	13,400	12,700	12,700	13,200	55	120	29
12	16,100	15,500	14,600	16,400	60	130	31
13	19,400	19,400	18,200	19,400	65	140	33
314	22,900	21,600	20,900	23,100	70	150	35
15	27,400	27,300	25,300	28,100	75	160	37
16	33,400	29,400	28,100	32,400	80	170	39
17	41,300	35,800	34,600	39,800	85	180	41
18	51,600	44,800	43,400	49,700	90	190	43
319	58,000	50,700	49,700	57,200	95	200	45
20	68,700	60,300	58,500	67,500	100	215	47
21	106,000	134,000	89,000	102,000	105	225	49
22	115,000	138,000	93,300	107,000	110	240	50
24	127,000	153,000	104,000	118,000	120	260	55

●スラスト自動調心ころ軸受

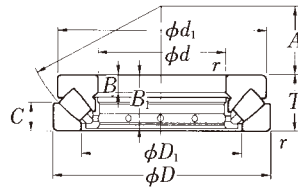

●29400

品番	価格	寸法			
		d (φ)	D (φ)	B (φ)	T(mm)
29412	69,100	60	89	130	42
13	74,900	65	96	140	45
14	86,300	70	103	150	48
15	92,500	75	109	160	51
16	103,000	80	117	170	54
29417	118,000	85	125	180	58
18	136,000	90	132	190	60
20	157,000	100	146	210	67
22	198,000	110	162	230	73
24	236,000	120	174	250	78
29426	271,000	130	189	270	85
28	317,000	140	199	280	85
30	401,000	150	214	300	90
32	482,000	160	229	320	95
34	554,000	170	243	340	103
29436	667,000	180	255	360	109
38	774,000	190	271	380	115
40	1,020,000	200	286	400	122
44	1,230,000	220	308	420	122
48	1,350,000	240	326	440	122
29452	1,590,000	260	357	480	132
56	1,830,000	280	387	520	145
60	2,010,000	300	402	540	145

●29200

品番	価格	寸法			
		d (φ)	D (φ)	B (φ)	T(mm)
29232	236,000	160	188	225	39
34	257,000	170	198	240	42
36	278,000	180	208	250	42
38	291,000	190	223	270	48
40	327,000	200	236	280	48
29244	470,000	220	254	300	48
48	487,000	240	283	340	60
52	563,000	260	302	360	60
56	602,000	280	323	380	60
60	854,000	300	353	420	73

●29300

品番	価格	寸法			
		d (φ)	D (φ)	B (φ)	T(mm)
29317	105,000	85	114	150	39
18	116,000	90	117	155	39
20	125,000	100	129	170	42
22	134,000	110	143	190	48
24	145,000	120	159	210	54
29326	157,000	130	171	225	58
28	177,000	140	183	240	60
30	207,000	150	194	250	60
32	242,000	160	208	270	67
34	274,000	170	216	280	67
29336	309,000	180	232	300	73
38	370,000	190	246	320	78
40	465,000	200	261	340	85
44	584,000	220	280	360	85
48	670,000	240	300	380	85
29352	820,000	260	329	420	95
56	980,000	280	348	440	95
60	1,140,000	300	379	480	109

●スラスト玉軸受



平面座形

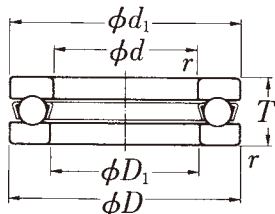

2900
3900
51100
51200
51300
51400

●51100

品番	価格	寸法			
		d (φ)	D (φ)	B (φ)	T(mm)
51100	1,380	10	11	24	9
01	1,390	12	13	26	9
02	1,400	15	16	28	9
03	1,420	17	18	30	9
04	1,450	20	21	35	10
51105	1,560	25	26	42	11
06	1,690	30	32	47	11
07	1,810	35	37	52	12
08	2,110	40	42	60	13
09	2,420	45	47	65	14
51110	2,690	50	52	70	14
11	3,160	55	57	78	16
12	3,700	60	62	85	17
13	4,010	65	67	90	18
14	4,420	70	72	95	18
51115	5,130	75	77	100	19
16	5,830	80	82	105	19
17	6,430	85	87	110	19
18	7,560	90	92	120	22
20	11,600	100	102	135	25
51122	20,600	110	112	145	25
24	26,800	120	122	155	25

●51200

品番	価格	寸法			
		d (φ)	D (φ)	B (φ)	T(mm)
51200	1,590	10	12	26	11
01	1,620	12	14	28	11
02	1,660	15	17	32	12
03	1,770	17	19	35	12
04	1,820	20	22	40	14
51205	2,050	25	27	47	15
06	2,270	30	32	52	16
07	2,800	35	37	62	18
08	3,170	40	42	68	19
09	3,500	45	47	73	20
51210	3,980	50	52	78	22
11	5,200	55	57	90	25
12	5,890	60	62	95	26
13	6,660	65	67	100	27
14	7,200	70	72	105	27
51215	8,080	75	77	110	27
16	8,960	80	82	115	28
17	11,500	85	88	125	31
18	14,000	90	93	135	35
20	19,400	100	103	150	38
51222	28,500	110	113	160	38
24	34,900	120	123	170	39

●51300

品番	価格	寸法			
		d (φ)	D (φ)	B (φ)	T(mm)
51305	2,800	25	27	52	18
06	3,190	30	32	60	21
07	3,860	35	37	68	24
08	4,750	40	42	78	26
09	5,620	45	47	85	28
51310	7,350	50	52	95	31
11	9,490	55	57	105	35
12	11,300	60	62	110	35
13	14,400	65	67	115	36
14	17,300	70	72	125	40
51315	20,800	75	77	135	44
16	22,700	80	82	140	44
17	27,600	85	88	150	49
18	31,700	90	93	155	50
20	40,600	100	103	170	55
51322	71,400	110	113	190	63
24	93,100	120	123	210	70

●51400

品番	価格	寸法			
		d (φ)	D (φ)	B (φ)	T(mm)
51405	5,370	25	27	60	24
06	5,430	30	32	70	28
07	6,860	35	37	80	32
08	8,240	40	42	90	36
09	10,400	45	47	100	39
51410	13,100	50	52	110	43
11	18,800	55	57	120	48
12	32,900	60	62	130	51
13	42,200	65	68	140	56
14	52,100	70	73	150	60
51415	60,700	75	78	160	65
16	80,600	80	83	170	68
17	102,000	85	88	180	72
18	135,000	90	93	190	77
20	173,000	100	103	210	85

調心座形

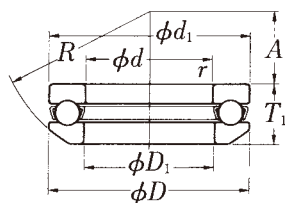

53200
53300
53400

調心座金付き



53200U
53300U
53400U